

Prime Conduit™ Split Duct

*Split Duct
Schedule 40*

*Split Duct
Schedule 80*

*Split Duct
Type C*

Couplings

Sweeps

Split Kits

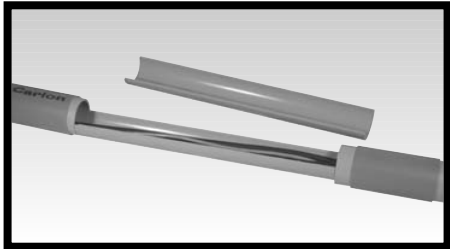
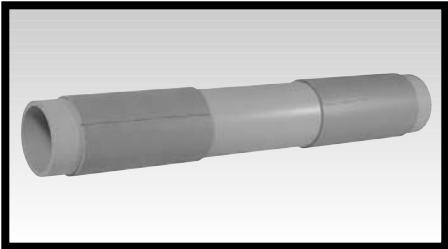
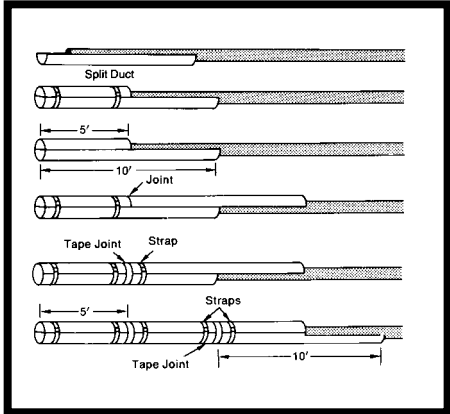

Prime Conduit™ Split Duct

Prime Conduit Split Duct is the fast and easy way to repair broken ductwork without the costly cutting and resplicing of your conductors.

Our unique tongue-and-groove design leads the industry in providing a strong, rigid solution for duct repair situations.

The interlocking design allows the split duct sections to be staggered and butted together. Joints may be sealed with tape and reinforced with plastic or metallic straps to produce a rigid, stable unit.

Manufactured from a compound designed specifically for power and telecommunications applications, Prime Conduit Split Duct exhibits superior impact strength.

Available in 2" through 6" diameters, this product line also contains couplings and sweeps necessary to complete the system.



The fast and easy method of installing duct around existing cable for repair and temporary installations.

Recommended Installation Procedure

1. Place one 10-foot Split Duct section under cable.
2. In order to stagger joints, saw another section in half (about 5 feet long).
3. Place 5-foot section over cable and snap the two sections together.
4. Place strap about one foot from the end and another strap about a foot from the joint where the ends of the top sections will butt.
5. Place another 10-foot Split Duct section over the open half of the bottom section, butt the ends tightly together and snap the sections together.
6. Place a length of tape around both sections of the Split Duct to cover the butted joint.
7. Place a strap about one foot beyond the taped joint.
8. Lay another length of Split Duct underneath cable, butt together, tape the butted joint and strap one foot on each side of the joint.
9. Repeat procedure.

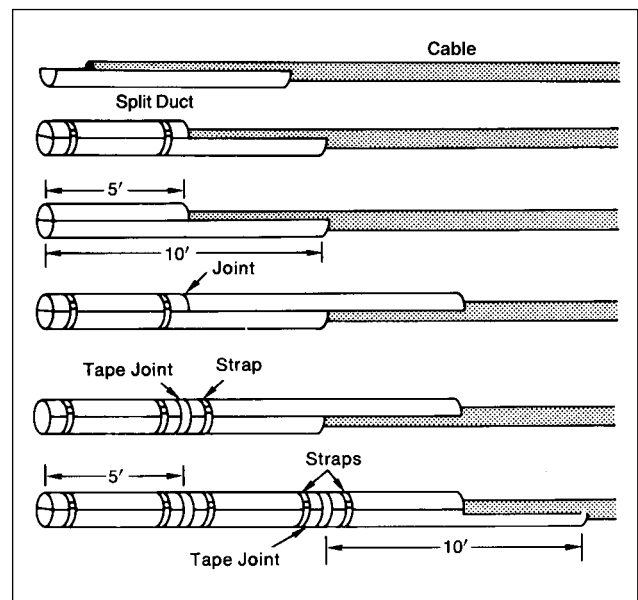

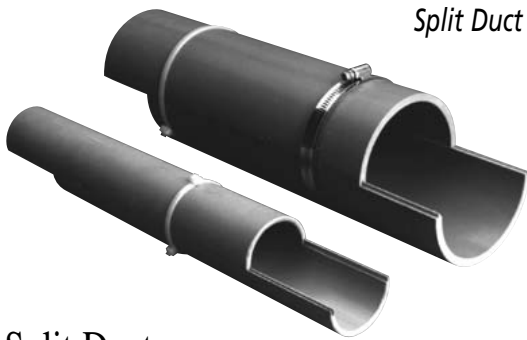

Split Duct



Split Sleeve Coupling
For joining Split Duct
to existing duct.

Split Duct

Part Number	Description	Std. Ctn. Qty.	Std. Ctn. Wt. (lbs.)	O.D.
Schedule 40				
49011SD-010	2" Schedule 40 Split Duct	700	523	2.375
49012SD-010	2 1/2" Schedule 40 Split Duct	460	562	2.875
49013SD-010	3" Schedule 40 Split Duct	500	802	3.500
49014SD-010	3 1/2" Schedule 40 Split Duct	290	560	4.000
49015SD-010	4" Schedule 40 Split Duct	290	662	4.500
49016SD-010	5" Schedule 40 Split Duct	230	718	5.563
49017SD-010	6" Schedule 40 Split Duct	130	523	6.625
Schedule 80				
49411SD-010	2" Schedule 80 Split Duct	700	702	2.375
49415SD-010	4" Schedule 80 Split Duct	290	890	4.500
C Duct				
68515SD-010	4" C Duct Split Duct	320	614	4.350

Split Sleeve Coupling

Part Number	Size	Description	length	Split	Std. Ctn. Qty.	Std. Ctn. Wt. (lbs.)
Schedule 40 and 80						
E200JS6	2"	Split Coupling	6"	1	25	6.1
E200KS7	2 1/2"	Split Coupling	7"	1	25	21
E200LS7	3"	Split Coupling	7"	1	25	15.5
E200LSS	3"	Split Coupling	6.5"	1	25	10
E200MS8	3 1/2"	Split Coupling	8"	1	25	41.2
E200NS8	4"	Split Coupling	8"	1	15	16
E200NSS	4"	Split Coupling	6"	1	25	17
E200PS8	5"	Split Coupling	8"	1	15	25
E200PS9	5"	Split Coupling	9"	1	8	16.4
E200RS1	6"	Split Coupling	10"	1	6	24.2
C Duct						
E900NS8 (White)	4"	C Duct Split Coupling	8"	1	15	19
E900NSW (White)	4"	C Duct Split Coupling	6"	1	25	22



Split Duct
Sweeps

Split Sleeve Sweeps

Segment	Part No.	Nom. Size	Radius (in.)	Std. Ctn. Qty.	Std. Ctn. Wt. (lbs.)
45° Sweep	UA7DJSD	2"	24"	1	1.4
	UA7FJSD	2"	36"	1	2.1
	UA7FLSD	3"	36"	1	4.7
	UA7HJSD	2"	48"	1	2.7
	UA7HLSD	3"	48"	1	6.1
	UA7IJS	2"	60"	1	3.2
	UA7ILSD	3"	60"	1	7.2
	UA7INSD	4"	60"	1	10.2
22 1/2° Sweep	UA5INSD	4"	60"	1	6.1
11 1/4° Sweep	UA3IJS	2"	60"	1	1
	UA3ILSD	3"	60"	1	3.6
	UA3INSD	4"	60"	1	5.1

Two 45° Elbows may be segmented for 90°.

Prime Conduit™ Split Kits

Prime Conduit Split Kits are specifically designed to make *Schedule-40 and Type-C* conduit repairs faster and easier! Damaged conduit can be repaired without disturbing the installed wire/cable system. Prime Conduit Split Kits come in handy 2 foot lengths with 7 inch split couplings on each end. UV-resistant for outdoor use, Split Kits feature the same durable tongue-and-groove design as Prime Conduit's Split Duct product.

Split Kits are manufactured from extra rugged PVC material. The unique design maintains the same physical performance and dimensional characteristics as the PVC pipe it is repairing! No other repair product can make this offer! The reason is in the interlocking/tongue-and-groove design that holds the true dimensions of the product, both I.D. and O.D., while maintaining the pipe's physical performance characteristics too.

**Prime Conduit™ Split Kits...
Conduit Repairs made Faster
and Easier.**

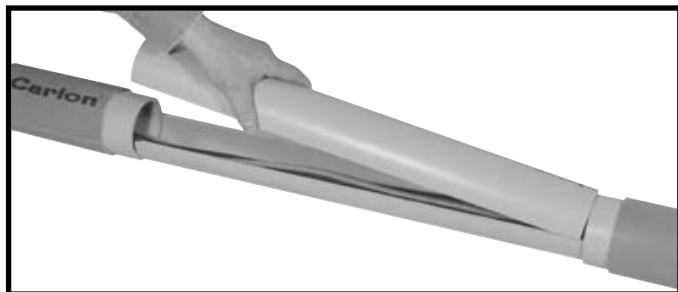
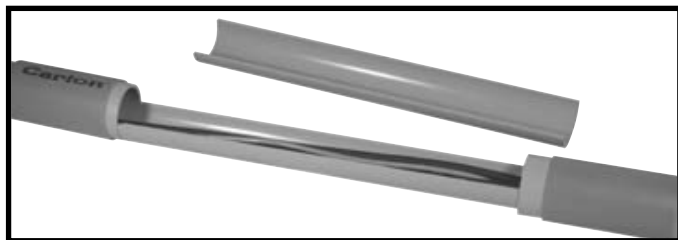
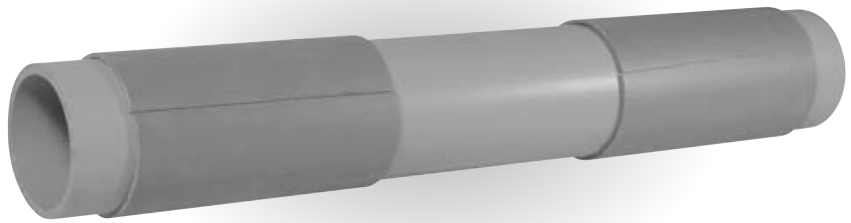

Features:

- Interlocking/tongue-and-groove design to assure dimensional pipe characteristics.
- Convenient and handy for easy handling, transport and storage.
- 2 ft lengths for fast/easy conduit repairs. Eliminates the need of cutting standard 10 ft. lengths to size. Get off the jobsite FASTER!
- Two 7" split couplings for a secure fit. Allows the product to be coupled together for longer repairs. Solvent cementable = water-resistant.
- Available in two wall types – Schedule 40 (Sizes 2" through 6"), and Type-C (4")
- Manufactured from extra rugged PVC – Lightweight, solvent cementable and compatible with all standard pipe fittings.

Specifications

Part Number	Size	Wall Type	Std. Carton Qty.	Std. Carton Wt. (lbs.)
SK4020	2"	Schedule 40	10	24.3
SK4025	2-1/2"	Schedule 40	10	49.2
SK4030	3"	Schedule 40	8	43.6
SK4040	4"	Schedule 40	5	40.5
SK4050	5"	Schedule 40	3	34.6
SK4060	6"	Schedule 40	2	36.4
SKC40	4"	Type C	5	36.2

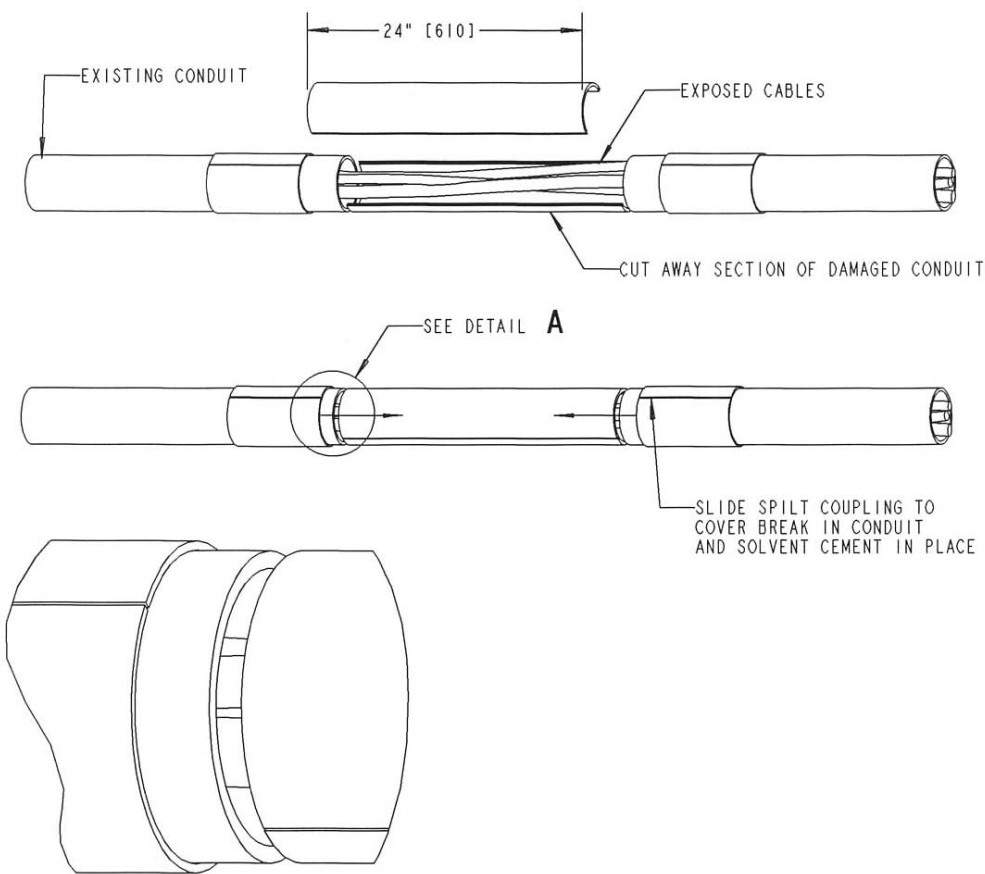

DETAIL **A**
SCALE 0.500